



SMETA

Since 2003



V2025

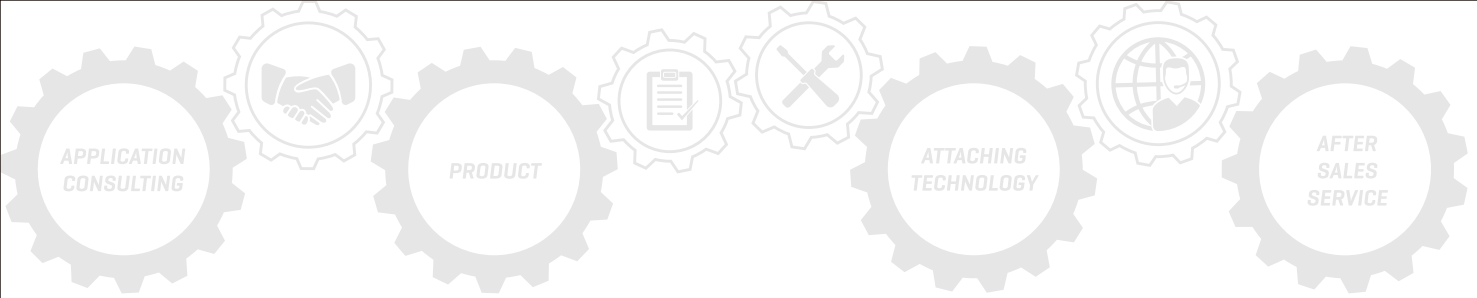

UNDERSTANDING OF SAFETY



SAFE FASTENING ELEMENTS?

100%



All parts are inspected by CCD vision inspection system to ensure the highest quality

- Highest certified quality worldwide
- High-quality raw materials (stainless steel, brass, various synthetics)
- For all kinds of textiles and purposes
- Individually developed specialist products in small quantities, available at short notice

Hot selling in the baby wear range

- Will neither tear nor come off
- Provides light to medium fastening strength
- Secure five-prong system
- Can be attached to all types of fabric – whether tight, stretch or knitwear
- Very flat design
- High level of wearing comfort and durability
- Countless colour, design and material variations





Are you sourcing products from agents or directly from factory?

Asiabutton is one of the leading factories that have 2 locations in China which is in Dongguan (6300 square meter) and Hubei Huang Guang (16000 square meter)



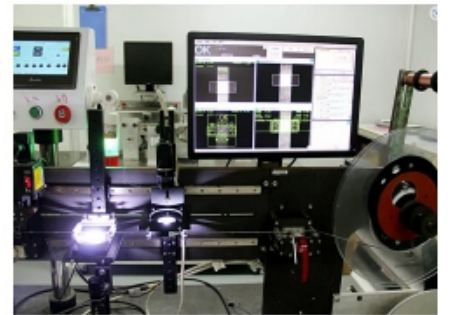
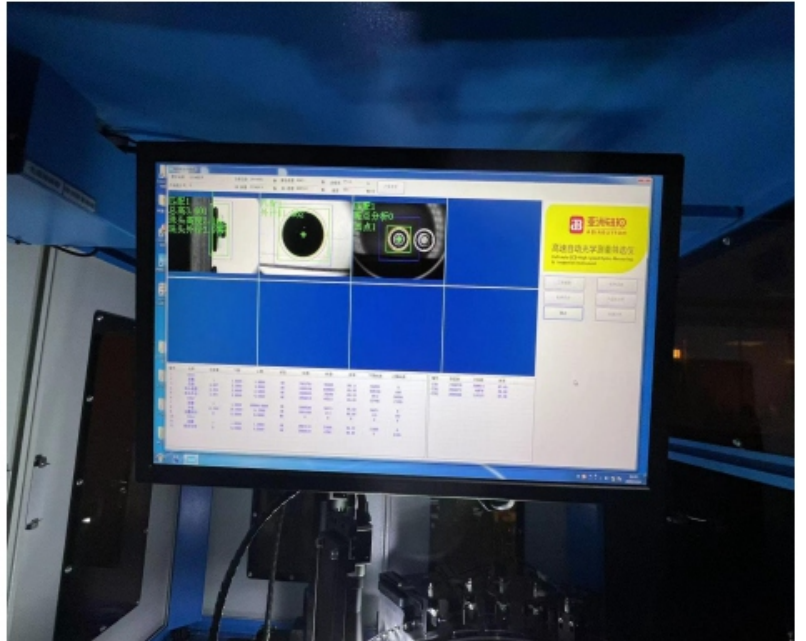



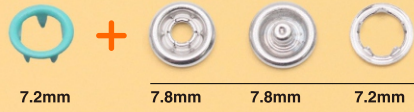

111#-Ring

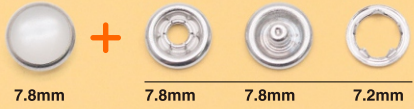

111#-Pearl

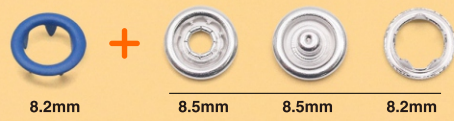

111.5#-Ring

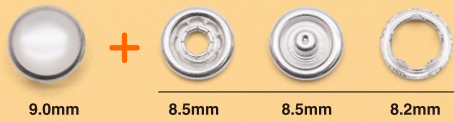

111.5#-Pearl



1#-Ring

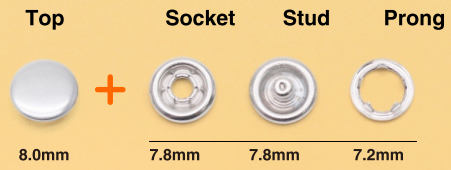

111#-Cap

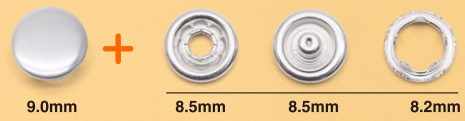

111.5#-Cap

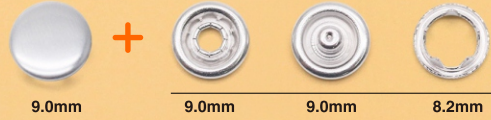

1#-Cap



Ab牌全自动打钮机
Fully Automatic Attaching
SnapButton Machine

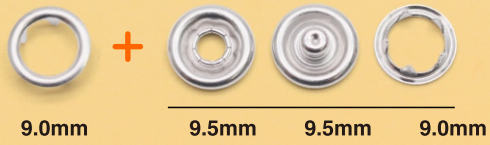

222#-Ring

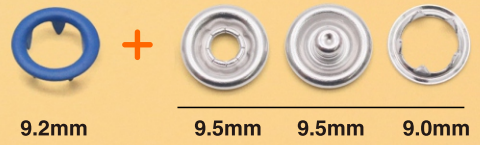

222#-Ring

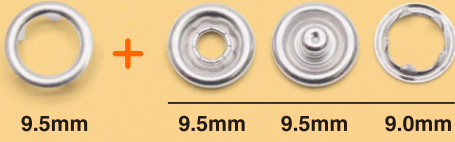

222#-Ring

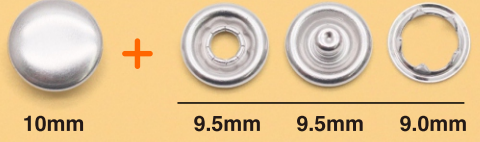

222#-Cap

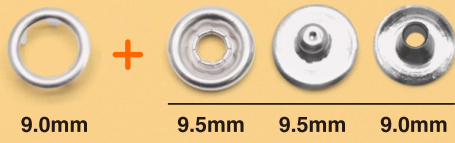

222#-B

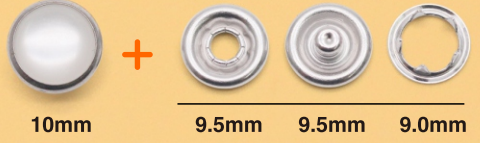

222#-Pearl

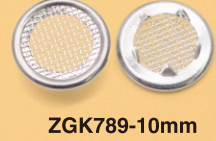
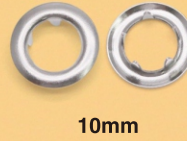

Ab牌全自动打钮机
Fully Automatic Attaching
SnapButton Machine

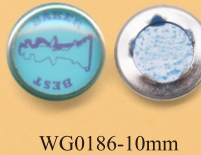
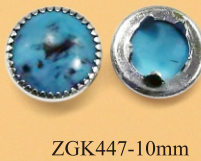

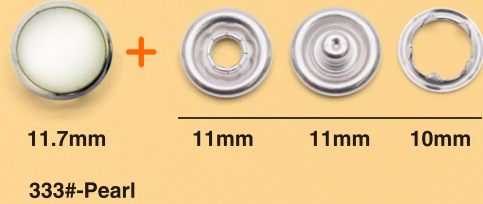
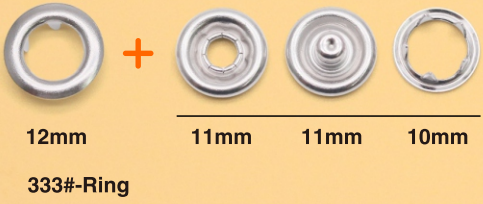
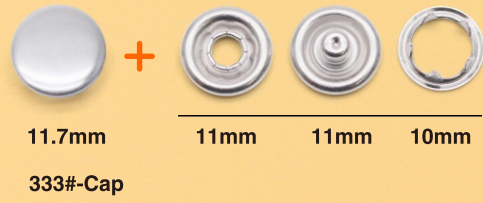
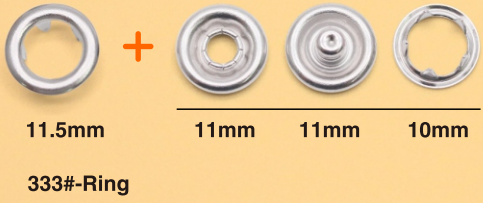
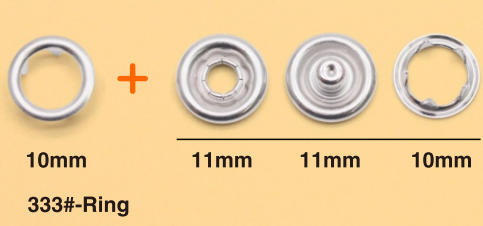

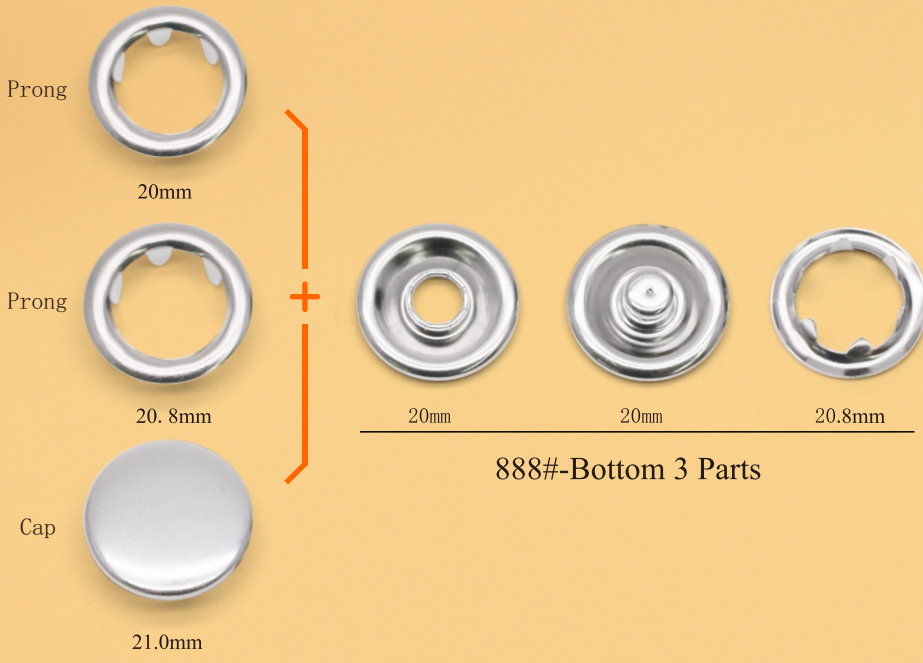
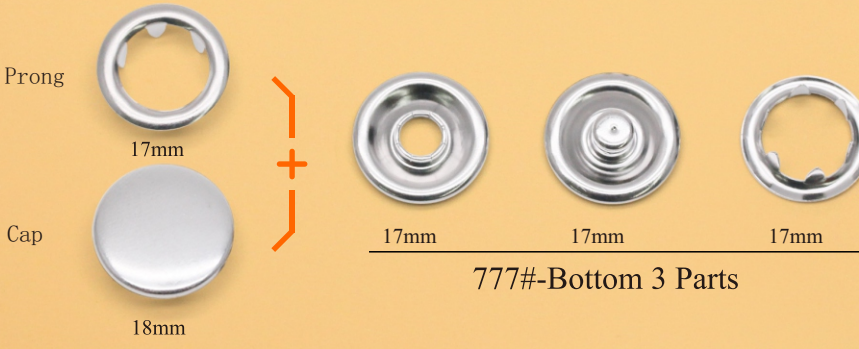
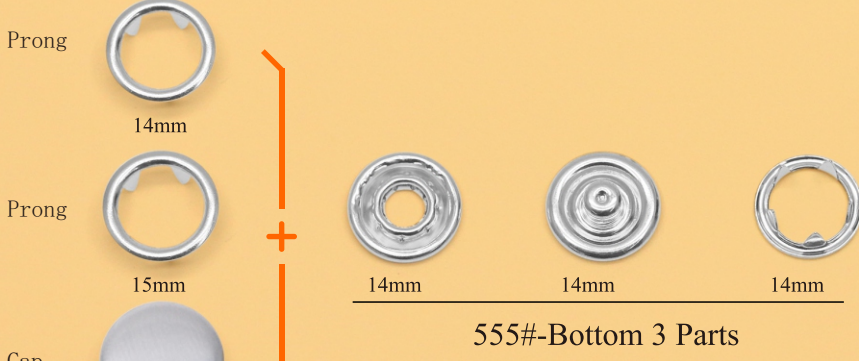

D Outer Diameter

d Inner Diameter

h Height

T Material Thickness

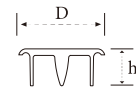

PRONG-RING SNAP BUTTON

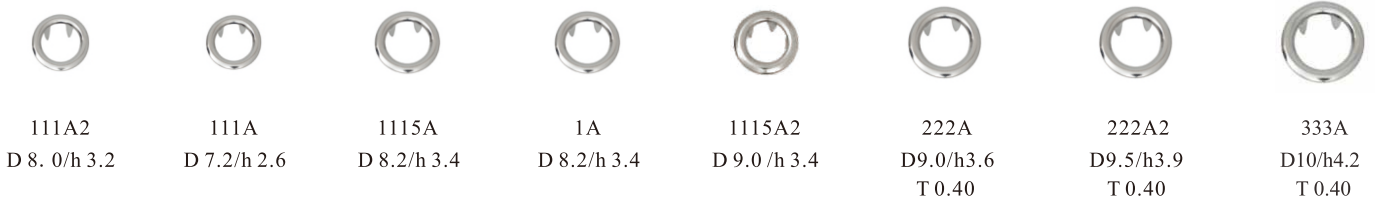

Stainless Steel Series

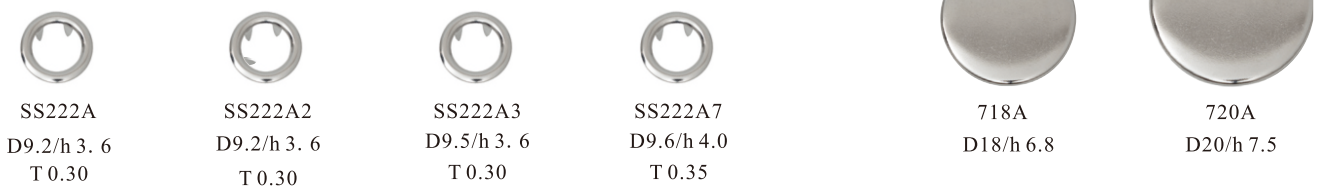

The product is made of H65 Brass Sheet stamped and can pass the Japanese needle detector.

PRONG-RING SNAP BUTTON

Ab牌全自动打钮机
Fully Automatic Attaching
Snap Button Machine



222A3

D9.5/h 3.9

T 0.45



222B2

D 9.5

T 0.30



222C2

D 9.5

T 0.30



222A3

D9.0/h 3.9

T 0.45



333A4

D10/h 4.4

T 0.45



333B2

D11.0

T 0.30



333C2

D11.0

T 0.30



333A4

D10/h 4.4

T 0.45

CAP PRONG SNAP BUTTON

10MM
Matt Black



Wa7137



SS111.5-3
Gun Metal

10MM
Matt Black



610A



Wa7263

12MM
Matt Black



Wa7261



Wa7262



SS222-3
Gun Metal

12MM
Dull Nickel



Wa7262



Wa7263

11MM
Matt Black



Wh3301

12MM
Matt Black



612A



SS333-3
Gun Metal

CAP OPTIONS FOR PRONG RING SNAP BUTTON

Crystal Top



1115A7

D 9.0 / h 5.21



222A10

D 10 / h 6.30



222A11

D 10.5 / h 6.3



333A14

D 11.5 / h 7.14



333A13

D 12.5 / h 7.26



555A7

D 15 / h 6.86



888A7

D 21 / h 10.86

Mesh Top



1115A4

D 9.0 / h 3.65



222A4

D 10 / h 3.80



333A5

D 11.5 / h 4.70

Transparent Top



222A7

D 10.5 / h 5.90



1115A8

D 9.0 / h 4.65



222A8

D 10 / h 5.50



333A15

D 12.5 / h 6.45



333A12

D 15 / h 6.60



888A8

D 21 / h 9.60

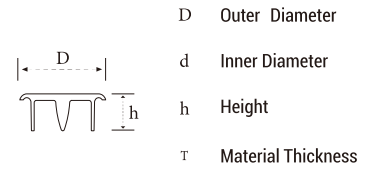

CAP OPTIONS FOR PRONG RING SNAP BUTTON

 Normal Cap

						
709A	710A	7115A	7125A	715A	718A	720A
D9/h3.8	D10/h3.8	D11.5/h4.7	D12.5/h5.0	D15/h 5.8	D18/h 6.8	D20/h 7.5

 Coin Cap

						
609A	610A	6115A	6125A	615A	618A	620A
D9/h4.3	D10/h4.8	D11.5/h5.7	D12.5/h6.0	D15/h 6.8	D18/h 7.8	D20/h 8.5
For 111.5#	For 222#	For 333#		For 555#	For 777#	For 888#

White Pearl

For 111.5#			For 222#			For 333#				
										
509A	510A	5105A	5115A	512A	5125A	514A	515A			
9.0mm	10.0mm	10.5mm	11.5mm	12.0mm	12.5mm	14.0mm	15.0mm			



333A57
 D12.0



222A12
 D 10 / h 5.25



333A16
 D 11.5 / h 5.30



333A17
 D 12 / h 5.45



333A18
 D 12.5 / h 5.90



333A19
 D 15 / h 6.85



333A58
 D12.5



222A13
 D 9x9 / h 5.70



333A20
 D 11x11 / h 6.30



333A21
 D 11x11 / h 6.30



333A59
 D 11x11 / h 6.30



333A22
 D 11x11 / h 6.30







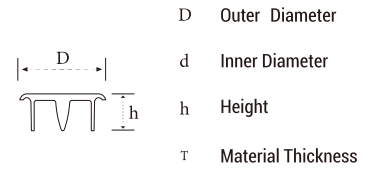











333A23
 D 11x11 / h 6.30

The product is made of H65 Brass Sheet stamped and can pass the Japanese needle detector.



CAP OPTIONS FOR PRONG RING SNAP BUTTON

 111A7 D9.0	 222A14 D10.0	 222A15 D10.5	 333A24 D11.5	 333A25 D12.0	 333A26 D12.5
Shiny White Chalk  222A16 D10.0	 222A17 D10.5	 333A27 D11.5	Im. Nickel Metal Prong  333A30 D11.5	Laser Logo Chalk  333A33 D11.5	
Matt White Chalk  222A18 D10.0	 222A19 D10.5	 333A28 D11.5	Anti Brass Metal Prong  333A31 D11.5	 333A34 D11.5	
Matt Black Chalk  222A20 D10.0	 222A21 D10.5	 333A29 D11.5	Anti Nickel Metal Prong  333A32 D11.5	 333A35 D11.5	
 333A37 D11.5	 333A38 D11.5	 333A55 D11.5	 222A24 D10.0	 222A25 D10.0	 333A36 D11.5
Thick Cap  222A22 D9.0	 222A23 D9.0	 333A39 D9.0			
 333A40 D12.0	 333A41 D12.0	 333A42 D12.0	 333A56 D12.0	 333A43 D15.0	 333A44 D15.0

The product is made of H65 Brass Sheet stamped and can pass the Japanese needle detector.

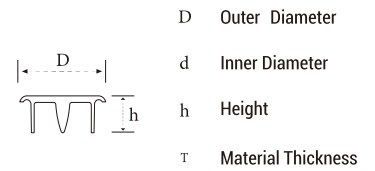

CAP OPTIONS FOR PRONG RING SNAP BUTTON

Sprayed Color Pearl



Spray Color Cap + Hand Filled Color



Wh4981



Wh4980



Wh4979



Wh4978



Wh4977



Wh4976



Wh4975



Wh4974



Wh4765

D12.0



Zg854

D10.0/11.5



W4315

D10.0



Wh4836

D10.0/11.5



Wa7380

D12.0



Wa7379

D12.0



Wa7278

D12.0



Wh3668

D12.5



Wa7026

D10.5



Wh4523

D10.0



Wa7379

D12.0



Wa7258

D16.0



Wh4498

D15.0



Wa7261

D12.0



Wa7262

D12.0



Wa7262

D12.0



Wa5152

D10.0



Wa5075

D11.0



Wa5153

D11.0



Wa3349

D10.0

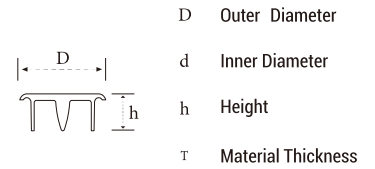

CAP OPTIONS FOR PRONG RING SNAP BUTTON



Wh7165
 D12.5/D14.0



Wa7167
 D12.5



Wa7169
 D12.5



Wa7171
 D12.5

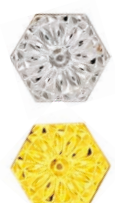

Wa7168
 D14.0

Screen printed Logo



1



2



3



4



5



6



7



8



9



10



11



12



13



14



Wa3130
 D11.0



Wh4984
 D12.0



Wa7509
 D12.0



Wa7508
 D12.0



Wa7507
 D12.0



Wa7511
 D12.0



Wa7492
 D12.0



Wa7400
 D12.0



Wh4982
 D12.0



Wa3807
 D9.0



Wa5607
 D10.5



Wh3301
 D12



Wh3301
 D10



Wa7512
 D12.0



Wh4983
 D12.0



Wh4623
 D10.0/15.0









Wh4622
 D10.0/15.0









Wh4624
 D10.0/15.0

Stainless Steel Prong - Ring snap Button







Ss111.5#

	Top				
Prong		8.2	Socket	Stud	Prong
Pearl		9.0			
Cap		9.0	8.5	8.5	8.2

Ss222#

		9.2			
		10.0			
		10.0	9.5	9.5	9.2

Ss333#

		10.0			
		11.7			
		11.7	11.0	11.0	10.0

- Applicable for various fabric thicknesses with two types of prong length available.
- Residual chlorine on fabric may cause corrosion.
- Color fade and corrosion may be determined on chemical resistance.
- Electric plating not available. Non-needle detector free.

Usage: Workwears, Uniforms, Medical wears, Babywear, umbrella, Stationery packing
High durability against rust and stable action force.
Applicable on various fabric, and on different thickness. Available prong length according to usage.

Since 2003

D Outer Diameter

d Inner Diameter

h Height

T Material Thickness

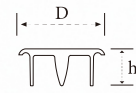

Pearl prong Snap Button



Pear Top Design Options



Top option

Bottom 3 parts



Unique Hand Painted Art made Pearl Snap Button

Size: 11.5mm/ 12.5mm



Z001



Z002



Z003



Z004



Z005



Z006



Z007



Z008



Z009



Z010



Z011



Z012



Z013



Z014



Z015



Z016



Z017



Z018



Z019



Z020



Z021



Z022



Z023



Z024



Z025



Z026



Z027



Z028



Z029



Z030



Z031



Z032



Z033



Z034



Z035



Z036



Z037



Z038



Z039



Z040



Z041



Z042



Z043



Z044



Z045



Z046



Z047



Z048

Unique Hand Painted Art made Pearl Snap Button

Size: 15.0mm





SMETA

Since 2003

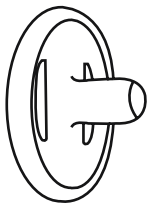

A

CAP



FABRIC



B

SOCKET

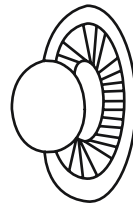

C

STUD



FABRIC

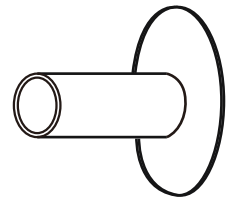

D

POST

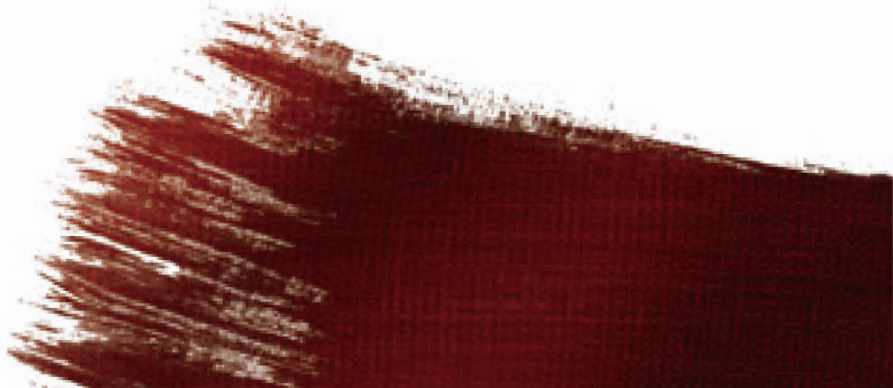

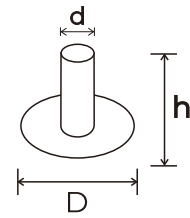

D Outer Diameter
 d Inner Diameter
 h Height
 T Material Thickness

S Spring Snap Fastener

CAP SOCKET STUD POST

108#



808A
D:8/h4.3

+



108B
D:8.0

+



108C
D:7.0

+



108D
D:7.5/h6.0

488#



809A
D:9/15 Line

+



488B
D:10.0

+



488B
D:9.0

+



488D3
D:8.5/h 5.8

.....



810A
D:10/16 Line

.....



488D
D:8.5/h 6.0

486#



8125A
D:12.5/20 Line
(Available Size:814A:14mm/815A:15mm)

+



486B
D:12.0

+



486C
D:10.5

.....



486C3
D:10.2

+



486D
D:10/h 7.8

.....



486D2
D:10.4/h 6.8

Hidden Cap



8150A
D:15.0/24 Line
(Available Size:817A:17mm)

+



486B2
D:12.0

+



486C4
D:10.5

+



486D3
D:10/h 6.8

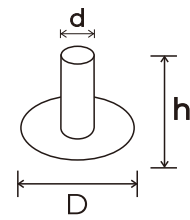

D Outer Diameter
 d Inner Diameter
 h Height
 T Material Thickness

S Spring Snap Fastener

CAP

SOCKET

STUD

POST

484#



+



+



+



815A

D:15/24 Line
 (Available size

814A:14mm,817A:17mm,820A:20mm)

484B

D:13.8

484C

D:11.5

484D

D:11.0/h 6.5



484D2

D:11.0/h 7.0



+



+



+



817A

D:17/27 Line

484B2

D:13.8

584C

D:11.5

584D

D:11.0/h 6.5

8050#



+



+



+



B815A

D:15.0/24 Line

(Available Size:B817A:17.0mm)

8050B

D:15.0

8050C

D:14.0/h 4.2

8050D

D:12.2/h 7.8



8050B4

D:15.0



8050B2
 Small Hole



8050B
 Big Hole



SMETA

Since 2003

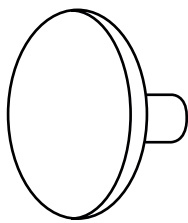

A

CAP



FABRIC



B

SOCKET

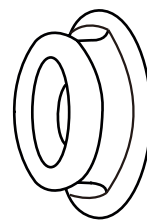

C

STUD



FABRIC

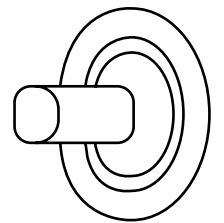

D

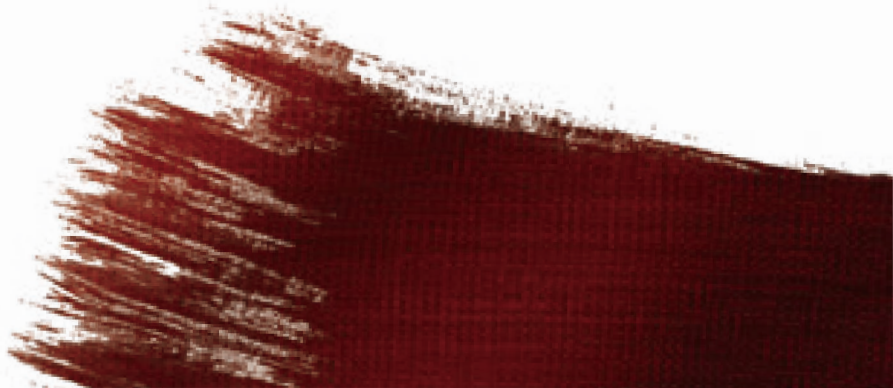

POST

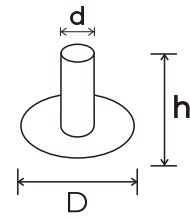













D Outer Diameter
 d Inner Diameter
 h Height
 T Material Thickness

S Spring Snap Fastener

CAP		SOCKET		STUD		POST	
406#		+		+		+	
	8125A D:12.5/20 Line		406B D:11.5		406C D:11.0		406D D:10.5/h 5.5

405#		+		+		+	
	B815A D:15.0/24 Line (Available size:B817A:17.0mm)		405B D:13.5		405C D:13.5		405D D:12.5/h 6.5





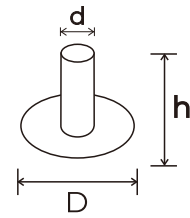























Caps		Middle Parts		Bottoms			
		+			+		
B815A	405B		405C3	405B		405B	405D

4061#		}		+		+	
	4061D D:11.0/17 Line		4061B D:11.0		4061C D:11.0		4061D D:11.0
4051#				+		+	
	4051D D:13.0/21 Line		4051B D:13.5		4051C D:13.0		4051D D:13.0
		+					
	4051A D:15.0/24 Line						4051A D:15.0



D Outer Diameter
 d Inner Diameter
 h Height
 T Material Thickness

New Style Snap Fastener

	CAP		SOCKET		STUD		POST
200#	 812A D:12.0	+	 200B D:13.0	+	 200C D:10.3	+	 200D D:9.5/h 7.6
504#	 504A D:15.0	+	 504B D:12.5	+	 504C D:12.5	+	 504D D:11.0
202#	 810A D:10.0	+	 202B D:11.0	+	 202C D:9.5	+	 202D D:10.0
201#	 812A D:12.0	+	 201B D:13.0	+	 201C D:11.5	+	 201D D:12
312#	 8125A D:12.5	+	 312B D:12.0	+	 312C D:12.0	+	 312D D:12.0/h 8.8
315#	 815A D:15.0	+	 315B D:15.0	+	 315C D:15.0	+	 315D D:12.0/h 7.5
317#	 817A D:17.0	+	 317B D:17.0	+	 317C D:17.0	+	 317D D:12.0/h 7.5

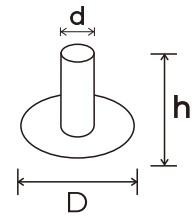

D Outer Diameter
 d Inner Diameter
 h Height
 T Material Thickness

New Style Snap Fastener



14mm 13.5mm 10mm 11mm

391#

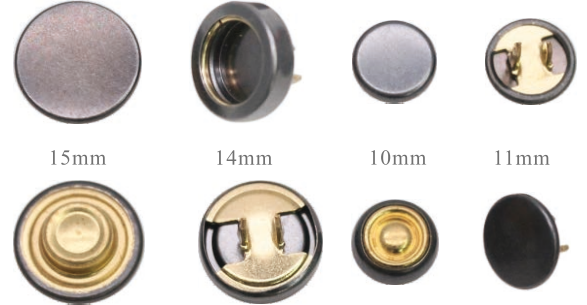

15mm 14mm 10mm 11mm

391D#



15mm 14mm 12.5mm 15mm

S630#-150



15mm 14mm 12.5mm 12mm

S633#-140



12.5mm 11mm 11mm 12.5mm

S530#-125



12.5mm 11mm 7.3mm 9.5mm

S531#-125



12.5mm 11mm 11mm 9.5mm

S532#-125



12.5mm 11mm 11mm 11mm

S533#-125

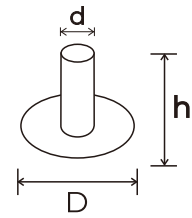

D Outer Diameter
 d Inner Diameter
 h Height
 T Material Thickness

New Style Snap Fastener

S637-3



501B2
 D:14.0



501C2
 D:12.5



501D2
 D:12.0/h 5.5

S389-3



501B2
 D:14.0



501C3
 D:10.0



501D2
 D:9.5/h 8.5

S633-3



501B2
 D:14.0



501C
 D:14.0



501D
 D:11.5/h 7.8

S641-3



501B
 D:14.0



501C2
 D:12.5



501D2
 D:12.0/h 5.5

S640-3



501B
 D:14.0



501C3
 D:10.0



501D2
 D:9.5/h 5.5

S501-3
 (S638-3)



501B
 D:14.0



501C
 D:12.5



501D
 D:11.5/h 7.8

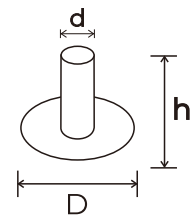

D Outer Diameter
 d Inner Diameter
 h Height
 T Material Thickness

New Style Snap Fastener

S537-3



503B2
D:11.0



503C2
D:11.0



503D2
D:9.5/h 5.5

S536-3



503B2
D:11.0



503C3
D:7.3



503D2
D:9.5/h 8.0

S538-3



503B2
D:11.0



503C
D:11.0



503D
D:11.0/h 7.8

S541-3



503B
D:11.0



503C2
D:11.0



503D2
D:9.5/h 5.5

S540-3



503B
D:11.0



503C3
D:7.3



503D2
D:9.5/h 5.5

S503-3

(S542-3)



503B
D:11.0



503C
D:11.0



503D
D:11.0/h 7.8

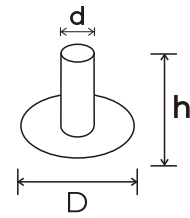

D Outer Diameter
 d Inner Diameter
 h Height
 T Material Thickness

Fish Eye Ring Snap Button

<p>CAP</p>  <p>407A2 D:17.0</p>	+	<p>SOCKET</p>  <p>401B D:16.0</p>	+	<p>STUD</p>  <p>401C D:15.0</p>	+	<p>POST</p>  <p>401D D:15.0/h 9.1</p>
<p>CAP</p>  <p>407A2 D:17.0</p>	+	<p>SOCKET</p>  <p>407B D:16.0</p>	+	<p>STUD</p>  <p>407C D:12.5</p>	+	<p>POST</p>  <p>407D D:12.5/h 8.5</p>
<p>CAP</p>  <p>407A3 D:19.0</p>	+	<p>SOCKET</p>  <p>402B D:15.0</p>	+	<p>STUD</p>  <p>402C D:12.0</p>	+	<p>POST</p>  <p>402D D:11.0/h 8.5</p>
<p>CAP</p>  <p>409A D:17.0</p>	+	<p>SOCKET</p>  <p>409B2 D:17.0</p>  <p>409B1 D:17.0</p>	+	<p>STUD</p>  <p>409C D:12.0</p>	+	<p>POST</p>  <p>409D D:11.0/h 9.5</p>

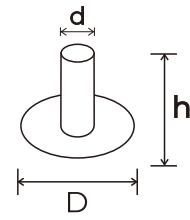

D Outer Diameter
 d Inner Diameter
 h Height
 T Material Thickness

Single side open snap button

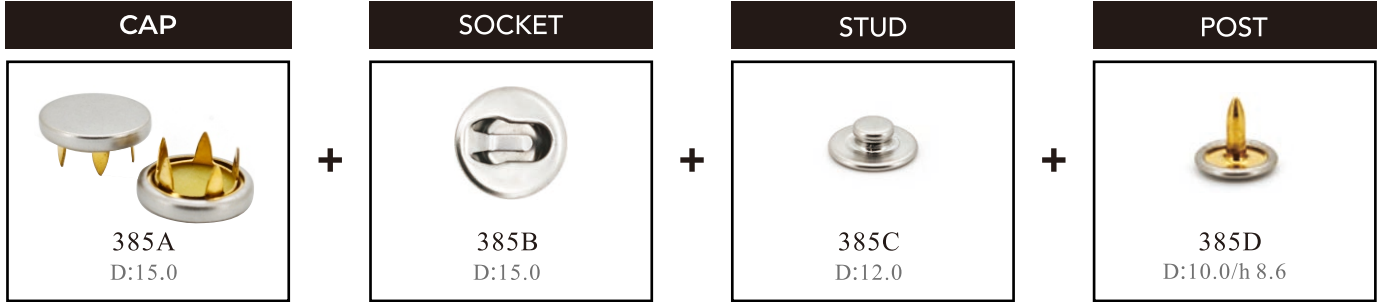

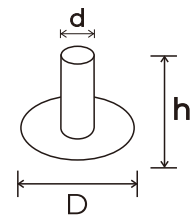

D Outer Diameter
 d Inner Diameter
 h Height
 T Material Thickness

Special flat cap snap Button

Patent product 专利产品



S392170



S392170C



S392170TC
 Cap Thick:2.6mm



17.0mm



12.3mm



11.0mm



15.0mm



20.0mm



23.0mm



15.0mm



20.0mm



23.0mm



12.3mm



12.3mm



12.3mm



11.0mm



11.0mm



11.0mm



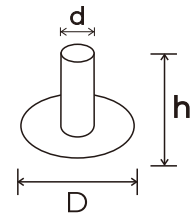

D Outer Diameter
 d Inner Diameter
 h Height
 T Material Thickness





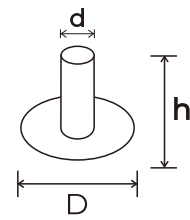



New Style Snap Button

	CAP		SOCKET		STUD		POST
419#	 8125A D:12.5	+	 419B D:11.0	+	 419D D:10.8	+	 419D D:11.0/h 7.8
903#	 8125A D:12.5	+	 903B D:12.3	+	 903C D:10.3	+	 903D D:10.5/h 7.5
901#	 815A D:15.0	+	 901B D:13.6	+	 901C D:12.3	+	 901D D:12.0/h 8.5
307#	 815A D:15.0	+	 307B D:15.0	+	 307C D:15.0	+	 307D D:11.0



D Outer Diameter
 d Inner Diameter
 h Height
 T Material Thickness

Magnetic Snap Button

	CAP		SOCKET		STUD		POST
309#	 8125A D:12.5	+	 309B D:13.0	+	 309C D:13.0	+	 309D D:10.0/h 8.7
310#	 815A D:15.0	+	 310B D:15.0	+	 310C D:15.0	+	 310D D:12.0/h 8.3
306#	 8125A D:12.5	+	 306B D:13.0	+	 306C D:13.0	+	 306D D:12.5/h 6.0
305#	 815A D:15.0	+	 305B D:15.0	+	 305C D:15.0	+	 305D D:12.5/h 6.0
398#	 398A D:17.0	+	 398B D:17.0	+	 398C D:17.0	+	 398D D:16.0

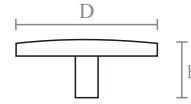

D Outer Diameter
 d Inner Diameter
 h Height
 T Material Thickness

Brass Cap



Wh1502
15mm



Wh1665
15mm



Wh1403
15mm



Wh1402
15mm



Wh1671
15mm



Wh1590
15mm



Wh1674
15mm



Wh1502
15mm



Wh1665
15mm



Wh1403
15mm



Wh1402
15mm



Wh1671
15mm



Wh1590
15mm



Wh1674
15mm



Wh3413
15mm



Wh2424
17mm



Wh1808
15mm



Wh0207
15mm



Wh2724
17mm



Wh0206
17mm



Wh300
17mm



Wh3311
10.0mm



Wh2022
11.5mm



Wh4421
12mm



Wh1484
14mm



Wh4202
15mm



Wh3370
17mm



Wh2451
20mm



Wh4588
15mm



Wh3329
15mm



Wh3231
16mm



Wh3230
15mm



Wh3229
15mm



Wh4891
15mm

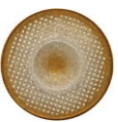

Wh2024
15mm



Wh2959
15/20mm



Wh2724
17mm



Wh2445
17mm



Wh1809
20mm



Wh2722
15mm



Wh3838
17mm

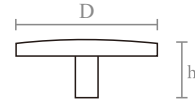

D Outer Diameter
 d Inner Diameter
 h Height
 T Material Thickness

Fine Plated Color Brass Cap

挂电金 FINE GOLD



10mm



11mm



12.5mm



14mm



15mm



17mm



19mm



20mm



23mm



25mm

挂电无叻 FINE NICKEL



10mm



11mm



12.5mm



14mm



15mm



17mm



19mm



20mm



23mm



25mm

挂电枪 FINE GUNMETAL



10mm



11mm



12.5mm



14mm



15mm



17mm



19mm



20mm



23mm



25mm

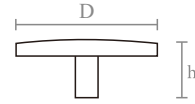

D Outer Diameter
 d Inner Diameter
 h Height
 T Material Thickness

Cap Options

Little Dome of Alloy Cap

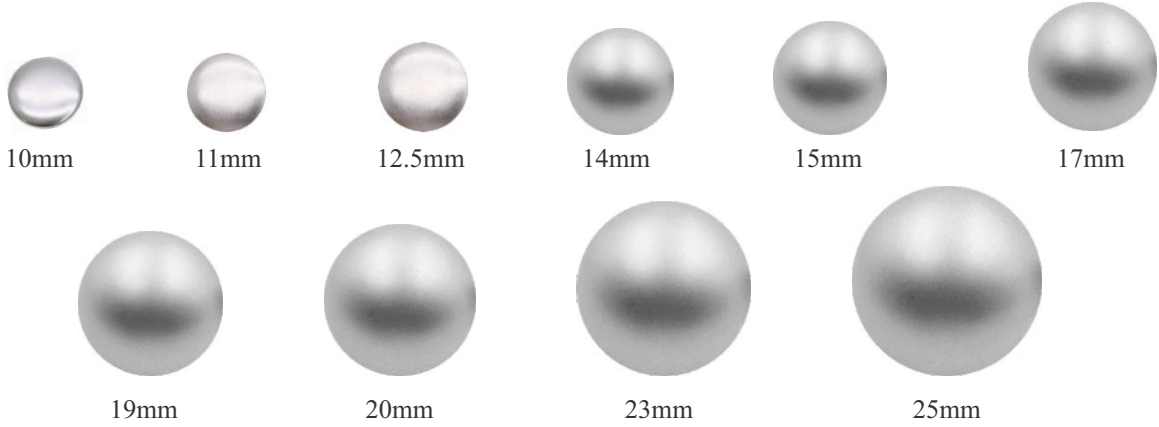

Brass Cap Options



Hidden Cap

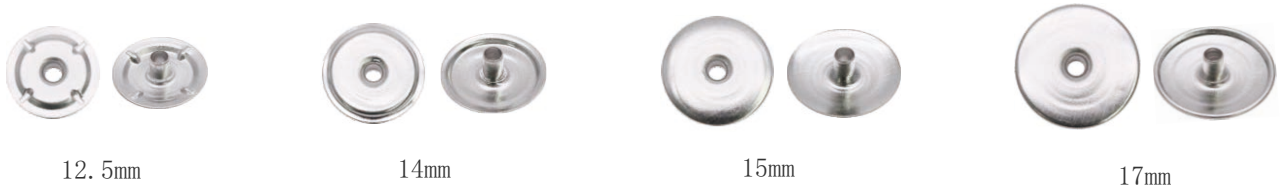

Standard Alloy Cap





SMETA

Since 2003



V2025

Eyelet W Washer



SKU	Description of Goods	Outer*Inner*Height	Weight Kg/10 K sets
E035	3.5mm Small Eyelet	3.5*2.0*3.0mm	0.41
E078AL	1/8 Eyelet W Alum Washer	7.8*4.0*4.6mm	2.00
E100AL	3/16 Eyelet W Alum Washer	10*5.3*5.5mm	3.50
E125AL	1/4 Eyelet W Alum Washer	12.5*7.0*5.8mm	4.60
E020AL	22# Eyelet W Alum Washer	11.5*6.0*4.7mm	4.30
E228AL	1/2# Eyelet W Alum Washer	22.8*13.5*7mm	11.9
E004	4# Eyelet W Washer	8.0*4.0*3.8mm	1.95
E003	3# Eyelet W Washer	8.3*4.5*4.3mm	2.15
E078	1/8 Eyelet W Washer	7.8*4.0*4.6mm	2.35
E002	2# Eyelet W Washer	9.5*5.0*4.7mm	2.80
E100	3/16 Eyelet W Washer	10.0*5.3*5.5mm	3.50
E020	20# Eyelet W Washer	11.5*6.0*4.7mm	3.85
E020W	20# Big Eyelet W Washer	12.0*6.0*4.7mm	4.15
E125	1/4 Eyelet W Washer	12.5*7.0*5.8mm	4.65
E022	22# Eyelet W Washer	13.8*8.0*4.7mm	5.65
.E023	23# Eyelet W Washer	15.0*8.0*5.5mm	6.70
E170	23# Big Eyelet W Washer	17.0*8.0*5.2mm	7.50

Eyelet W Washer



SKU	Description of Goods	Outer*Inner*Height	Weight Kg/10 K sets
E024	24# Eyelet W Washer	17.0*10.0*5.0mm	7.42
E180	24# Big Eyelet W Washer	18.0*10.0*5.8mm	9.35
E190	19mm Eyelet W Washer	19.0*11.0*6.3mm	11.0
E200	20mm Eyelet W Washer	20.0*10.0*6.5mm	11.5
E026	26# Eyelet W Washer	21.0*12.0*6.5mm	13.0
E228	1/2# Eyelet W Washer	22.8*13.5*7.0mm	15.0
E230	23mm Eyelet W Washer	23.0*12.0*7.0mm	14.5
E028	28mm Eyelet W Washer	23.5*13.5*6.9mm	14.7
E254	1 Inch Eyelet W Washer	25.4*13.5*6.5mm	17.0
E250	1 Inch Eyelet W Washer	25.0*12*6.5mm	17.5
E280	28# Eyelet W Washer	28.0*14*6.5mm	30.0
E029	29# Eyelet W Washer	28.0*16*7.2mm	29.7
E030	30# Big Eyelet W Washer	28.5*17*6.9mm	30.2
E300	30mm Eyelet W Washer	30*14.0*6.9mm	32.0
E350SS	35mm SS Eyelet W Washer	35*20.0*6.6mm	29.0
E400	40mm Eyelet W Washer	40.2*26*7.5mm	52.0
E450	45mm Big Eyelet W Washer	45*26.0*7.0mm	60.0
E500SS	50mm SS Eyelet W Washer	50*30.0*7.0mm	56.0
E620SS	62mm SS Eyelet W Washer	62*40.0*7.0mm	78.5

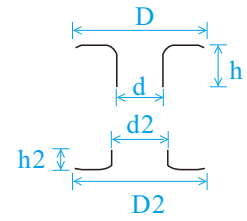

Double Eyelet



SKU	Description of Goods	Outer *Inner* Height (Outer *Inner*Height)	Weight Kg/10 K sets
E004D	4# Double Eyelet	8.0*4.0*4.0(8.0*4.5*2.7)	3.8
E002D	2# Double Eyelet	9.5*5*4.7(9.5*5.5*2.7)	4.0
E020D	20# Double Eyelet	11.5*6.0*4.7(11.5*6.5*2.7)	5.1
E120D	12mm Double Eyelet	12.0*7.0*4.5(12.0*8.0*2.7)	
E022D	22# Double Eyelet	13.8*8*4.7(13.8*8.5*2.7)	7.0
E023D	23# Double Eyelet	15.0*8.0*5.2(15.0*8.5*2.7)	
E024D	24# Double Eyelet	17.0*10.0*5.0(17.0*11.0*2.7)	10.2
E160D	16mm Double Eyelet	16.0*9.0*5.0(16.0*10.0*2.7)	9.0
E026D	26# Double Eyelet	21.0*12.0*6.5(21.0*13.0*2.7)	14.7
E230D	23mm Double Eyelet	23.0*10.5*8.0(23.0*11.2*2.0)	
E400D	40mm Double Eyelet	40.2*26*7.5(40.2*27*1.6)	

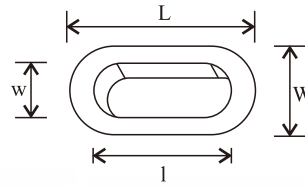

Oval Eyelet W Washer



SKU	Description of Goods	Outer Length*Width (Inner Length * Width)	Weight Kg/10 K sets
Oe150	5/8 Inch Oval Eyelet W Washer	21.0*12.0(15.5*5.5)	7.42
Oe170	21/32 Inch Oval Eyelet W Washer	23.0*12.0(17.0*5.5)	9.35
Oe190	3/4 Inch Oval Eyelet W Washer	26.0*12.0(19.0*5.5)	11.0
Oe210	13/16 Inch Oval Eyelet W Washer	27.0*12.0(21.0*5.5)	11.5
Oe230	7/8 Inch Oval Eyelet W Washer	30.0*12.0(23.0*5.5)	13.0
Oe250	1 Inch Oval Eyelet W Washer	32.0*12.0(25.5*5.5)	15.0
Oe300	1-1/4 Inch Eyelet W Washer	37.0*14.5(30.0*6.4)	13.0
Oe400	40mm Eyelet W Washer	50.0*6.0(40.0*3.0)	15.0

Special Shape Eyelet

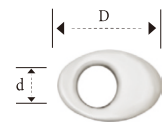

A-17

D: 12 mm
 H: 5.95 mm
 d: 4.73 mm
 MT: 0.25 mm

A-18

D: 17.96 mm
 H: 4.30 mm
 d: 11.30 mm
 MT: 0.25 mm

A-20

D: 7.90 mm
 H: 5.39 mm
 d: 4.35 mm
 MT: 0.25 mm

A-21

D: 8.79 mm
 H: 4.38 mm
 d: 2.33 mm
 MT: 0.25 mm

A-22

D: 10.95 mm
 H: 5.25 mm
 d: 4.80 mm
 MT: 0.25 mm

A-19

D: 13.75 mm
 H: 6.43 mm
 d: 4.84 mm
 MT: 0.23 mm

OEKO
TEX®

Higg
Index

Higg Family
Sustainable
Module

SMETA



WhatsApp



Wechat

AsiaButton

Head Office: B1205 ShenYip U Center Bei'Er Road HeZhou BaoAn District
ShenZhen 518126 China
Tel: +86-755-29802200 29802255

Factory1: DongGuan Wei Hua Industrial Ltd

东莞市炜华实业有限公司
No.78 ShiGu Industrial Road TangXia Town DongGuan City 523731 China
东莞市塘厦镇石鼓工业路78号
Tel: +86-769-82108000 Fax: 82107000

Factory2: Weihua High-tech (Hubei) Joint-stock Co., Ltd

炜华高科 (湖北) 股份有限公司
Sino-German High-Tech Park HuangMei County HuangGang City 435500 China
黄冈市黄梅县经济开发区中德高科园
400-965-9255

HongKong Office

Wei Hua International Ltd
+852 8191 5998

NewYork

+1 917 310 1630
info@asiabutton.com
www.asiabutton.com

